



> Quick Selection Table for Universal Circuit Breakers

EH	W	5	DC	--	□	/	4	Intelligent controller	4000	Installation	Connection method	B1
<p>Design Code</p> <p>Air circuit breaker</p> <p>Design number</p> <p>Direct current (D.C.)</p> <p>I_{rm}= 2500</p> <p>I_{rm}= 4000</p> <p>2-pole</p> <p>3-pole</p> <p>4-pole</p> <p>Intelligent Controllers</p> <p>M Intelligent</p> <p>3M LCD Standard</p> <p>3H LCD Communication</p> <p>200A、400A、630A、800A、1000A、1250A、1600A、2000A、2500A、2900A、3200A、3600A、4000A</p> <p>C Drawer type</p> <p>F Fixed</p> <p>Drawer Horizontal</p> <p>Drawer Vertical</p> <p>Fixed Horizontal</p> <p>Fixed Vertical</p> <p>Wiring Method</p> <p>2500:2-pole string;</p> <p>3-pole string, 4-pole string (see diagram)4000:2-pole string,</p> <p>3-pole string 4-pole strings(see picture)</p>												

Description:Standard configuration: intelligent controller for M type, auxiliary switch for four sets of changeover contacts, connection mode for the horizontal rear; intelligent controller, shunt debutor, undervoltage debutor, closing solenoid electric operating mechanism should indicate the voltage value. Note: H-type controller should be equipped with power conversion module.

> Product Overview

EHWSDC series universal circuit breakers (hereinafter referred to as circuit breakers) are suitable for DC rated current 800A-4000A, rated insulation voltage DC1500V, rated working voltage DC1000V/750V, DC1000V/1500V in the power distribution network. It is used to distribute electric energy and protect lines and power supply equipment from overload, undervoltage, short circuit and other faults; it also has a reliable isolation function. The circuit breaker has a variety of protective functions, while achieving highly accurate selective protection, it can also avoid unnecessary power outages and improve the reliability and safety of the power supply system. This circuit breaker has selective protective function, realizing graded cooperation protection between circuit breaker levels and backup protection to reduce the accident scope of the power grid. Therefore, it is especially suitable for the protection system of large-capacity DC current power supply.

The product conforms to GB/T 14048.2 standard.

> Normal operating conditions and installation conditions

The circuit breaker can be operated under the condition of ambient air temperature of -5°C-+40°C (greater than +40°C, see the capacity reduction factor of the circuit breaker). The altitude of the installation site does not exceed 2000m (see the high altitude derating factor of the circuit breaker if it is greater than 2000m). The relative humidity of the air at the installation site does not exceed 50% at a maximum temperature of +40°C; at lower temperatures there can be higher relative humidity, e.g. up to 90% at 20°C. Special measures should be taken for occasional condensation due to temperature changes.

Pollution class 3;

The installation category of the main circuit of the circuit breaker and the undervoltage striker coil, the primary coil of the power transformer is center, and the installation category of the rest of the auxiliary circuits and control circuits is 'M'.

Circuit breaker for electromagnetic environment.

Circuit breaker should be installed according to the instruction manual installation requirements. Vertical inclination of the circuit breaker should not exceed 5°. When the rated working voltage of the main circuit is DC750V-DC1500V, the control and auxiliary circuits need to be isolated from the main circuit by a transformer, and the maximum working voltage of the control and auxiliary circuits is AC400V, and the installation category of the control and auxiliary circuits are 'M'.

The protection class is IP20, and the protection class can reach IP40 when the circuit breaker is installed inside the cabinet and the door frame is added.

Technical parameters and performance circuit breakers

Breaker	EHWSDC-2500		EHWSDC-4000	
Number of series poles(P)	2, 3, 4		3, 4	
Rated current In(A)	800, 1000, 1250, 1600, 2000, 2500		1600, 2000, 2500, 3200, 3600, 4000	
Rated working voltage Ue(V)	DC500V/750V(2P, 3P) DC1000V/1500V(4P)		DC500V/750V(3P), DC1000V/1500V(4P)	
Rated insulation voltage Ui(V)	1500		1500	
Rated impulse withstand voltage Uimp(kV)	12		12	
Rated ultimate short-circuit breaking capacity Icu(kA)	DC500V	2P	50	/
		3P	65	120
	DC750V	2P	40	/
		3P	55	80
	DC1000V	4P	50	75
DC1500V	4P	40	60	
Rated operating short-circuit breaking capacity Ics(kA)	100% Icu		100% Icu	
Rated short-circuit breaking capacity Icm(kA)	100% Icu		100% Icu	
Rated short-time withstand current Icw(kA)/s	100% Icu		100% Icu	
Installation	Fixed	●		●
	Drawer type	●		●
Full segment time (no additional delay)			25~30ms	
Closing time			≤70ms	
Mechanical life (with maintenance)	20000		20000	
Mechanical life (without maintenance)	10000		10000	
Electrical life/Wiring method (horizontal)	7000		6000	
Wiring method (vertical)			●	
Wiring method (top horizontal, bottom vertical)			●	
Wiring method (top vertical, bottom horizontal)			●	

Note: The mechanical life of the drawer seat is 100 times, from "Separation" to "Connection" to "Separation" is one time, and the operation cycle is 1 time/2min.

Power loss

Product Model	Shell frame current (A)	Power loss (W)	
		Drawer/4P	Fixed/4P
EHWSDC-2500	2500	625	320
EHWSDC-4000	4000	960	510

Note: The power consumption of circuit breaker is the total power consumption measured under the rated shell current, this data can only be used as a general selection guide, not as a power loss in actual use.

The recommended cross-sectional area of the external conductor should correspond to the rated current of the circuit breaker to ensure normal operation of the circuit breaker.

Rated current (A)	External copper wire specification (with thickness)	Number of roots per terminal	Cross-sectional area per terminal (mm ²)
800	50×5	2	500
1000	60×5	2	600
1250	80×5	2	800
1600	100×5	2	1000
2000	100×5	3	1500
2500	100×5	4	2000
2900	100×10	3	3000
3200	100×10	4	4000
3600	100×10	5	5000
4000	100×10	5	5000

Elevation reduction factor

Altitude(m)	2000	3000	4000	5000
Reduction factor of working current	1	0.93	0.88	0.82
Short-circuit breaking capacity reduction factor	1	0.83	0.71	0.63
Frequency withstand voltage(V)	3500	3150	2500	2000

DC Series Connection Method

Wiring Method	2P tandem	3P tandem(A1)	3P tandem(A2)	3P tandem(A3)	3P tandem(A4)
Wiring Method					
Wiring Method					
Wiring Method	3P tandem(B1)	3P tandem(B2)	4P tandem(C1)	4P tandem(C2)	4P tandem(C3)
Wiring Method					
Wiring Method					

DC Series Connection Method

Number of series cascades	4P tandem(C4)	4P tandem(C5)	4P tandem(C6)	4P tandem(C7)	4P tandem(C8)
Wiring Method	front view	front view	front view	front view	front view
	3D rear view	3D rear view	3D rear view	3D rear view	3D rear view

Number of series cascades	4P tandem(D1)	4P tandem(D2)		
Wiring Method	front view	front view		
	3D rear view	3D rear view		

Note: All of the above installation methods can meet the requirements of top and bottom feeds and no polarity.

Intelligent controller protection characteristics (LCD type)

Intelligent control interface description

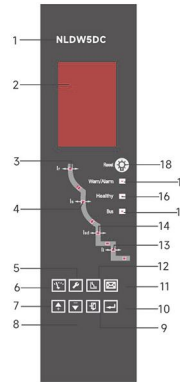

- 1 Intelligent controller model (corresponding to the product model).
- 2 LCD liquid crystal display window: it can display the current value of each phase, voltage value, setting parameters, fault current, time of release and information query and other parameters.
- 3 Overload long-delay fault indication; 4 Short-circuit short-delay inverse time limit.
- 4 Short-circuit short delay inverse time fault indication.

- 5 Setting key: Quickly switch to the main menu of parameter setting, (under the password input interface is "right" key).
- 6 Measurement key: Quickly switch to the default main menu of measurement, (under the password input interface is "right" key).
- 7 Up key: to move up the menu contents at the currently used level, or to change the selected parameter upwards;
- 8 Down key: to move up the menu contents at the currently used level, or to change the selected parameter upwards.
- 9 RETURN key: Exit the current level to the previous menu, or cancel the selection of the current parameter.
- 10 OK key: to enter the next level of the menu to which the current item refers, or to make the selection of the current parameter and store the modifications made;
- 11 Query key: switch to the history and maintenance theme menu.
- 12 Protection parameter setting key: switch to the protection parameter setting theme menu.
- 13 Short-circuit instantaneous fault indication
- 14 Short-circuit short-delay time-fixed fault indication;
- 15 Communication indication: Problems of Proximity and short-circuit short-circuits
- 16 Normal indication: under power-on condition, the working status is normal, the LED always flashes green.
- 17 Fault/Alarm indication: "Fault/Alarm" LED does not light up during normal operation; when the fault is tripped, "Fault/Alarm" LED will be red and blinking rapidly; LED will be red and light up constantly when alarm occurs.
- 18 Reset key: when the reset button is pressed, the LED will go out when there is no communication and blink when communication occurs.

Intelligent control and protection features

Overload long delay protection

The overload long delay protection function is generally used to protect cables against overloads, and the protection is based on the true RMS of the current. Overload long delay inverse time limit protection, adjustable rectification current I_r , adjustable delay time t_r , adjustable characteristics of the multi-curve, respectively, general-purpose (U²t), very inverse time (It), high-voltage fuse with the type (I²t) to meet the upper and lower levels of overload protection selectivity and matching needs.

Characteristics of undervoltage protection

Characterization	Current multiplier (Uaction setting value)	Approximate decoupling time	Allowable Delay Tolerance
Inoperative Characteristics	>1.1	No movement.	
Motion Characteristics	<0.9	Movement	
Motion Characteristics	≤0.9	The time limit characteristic is equal to the set delay time	10% (Inherent Absolute Error: 40ms)

Undervoltage protection alarm feature (only available when "Alarm" is selected as the actuating mode)

Characterization	Current multiplier (Uaction setting value)	Approximate time of decoupling	Allowable Delay Tolerance
Do not return features	<0.9	No return	
Return Characteristics	>1.1	Return	
Return delay	≥1.1	Time limit characteristic equal to set delay time	10% (Inherent Absolute Error: 40ms)

Overpressure protection

Principles of overvoltage protection behavior

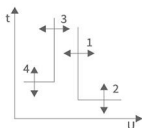

- 1: Action Threshold
- 2: Action delay time
- 3: Return threshold
- 4: Return delay time

Figure 2 Overvoltage protection action principle

When the voltage is greater than the action threshold (1) start alarm or trip delay, action delay time (2) to the alarm or trip signal, over-voltage trip or under-voltage fault DO action; when the voltage is less than the return threshold (3) when the return delay, when the return delay time (4) to the withdrawal of the alarm, under-voltage fault DO return.

Overvoltage protection parameter setting (undervoltage setting must be less than overvoltage setting)

Parameter name	Setting range	Recit-fication step	Remarks
Protection startup set value	80V-UmaxV	1V	Umax is set according to the rated voltage
Protective action delay time set value	0.2-60s	0.1s	
Protective action return delay set value	80V- Action Setting Value	1V	This value is available only when the execution mode is alarm, and the return value must be greater than or equal to the start value.
Protection return delay time	0.2-60s	0.1s	
Protection alarm DO output	Set one DO to "overpressure fault" (if not set, the alarm message can only be read from the controller display, no contact output).		
Execution mode		Alarm/Trip/Off	

Overvoltage Protection Characteristics

Characterization	Current multiplier (Uaction setting value)	Approximate time of decoupling	Allowable Delay Tolerance
Inoperative Characteristics	<0.9	No movement.	
Motion Characteristics	>1.1	Movement	
Motion Characteristics	≥1.1	The time limit characteristic is equal to the set delay time	10% (Inherent Absolute Error: 40ms)

Overvoltage protection alarm feature (only available when the execution mode is "Alarm")

Characterization	Current multiplier (Uaction setting value)	Approximate time of decoupling	Allowable Delay Tolerance
Do not return features	>1.1	No return	
Return Characteristics	<0.9	Return	
Return delay	≤0.9	Time limit characteristic equal to set delay time	10% (Inherent Absolute Error: 40ms)

Regional chains (Zsl)

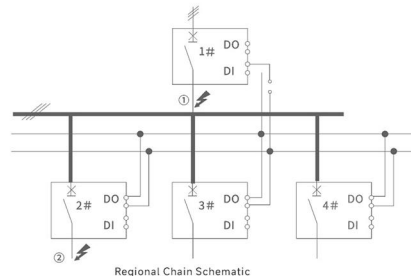

Area selective interlocking includes short circuit interlocking. In the same power circuit of two or more units with upper and lower associated circuit breakers.

When a short-circuit fault occurs at the outgoing side (e.g. position ②) of the lower-level circuit breaker (2#-4# circuit breakers), the lower-level circuit breaker trips instantaneously and sends an area interlocking trip signal to the upper-level circuit breaker; the upper-level circuit breaker (1# circuit breaker) receives the area interlocking trip signal and performs a time delay in accordance with the short-circuit protection setting. If the fault current is eliminated during the delay process of the superior circuit breaker, the protection returns and the superior circuit breaker does not act; if the fault current is still not eliminated after the tripping of the inferior circuit breaker, the superior circuit breaker acts according to the short-circuit protection setting and removes the fault line.

When the short-circuit fault occurs in the upper circuit breaker (1 # circuit breaker) and the lower circuit breaker (2 # - 4 # circuit breaker) remove the fault line, the upper circuit breaker did not receive the regional interlocking signals, and thus as usual, tripped to quickly remove the fault line.

Parameter setting: at least one D1 of the upper circuit breaker is set as area interlocking detection; at least one DO of the lower circuit breaker is set as area interlocking signal output.

Communication function
 Controller through the communication port in accordance with the requirements of the specified protocol can be realized by telemetry, remote control, remote control, telecommunication and other "four remote" data transmission function, for details, please refer to the "DC Frame Circuit Breaker Communication Protocol".

Communication parameter setting

Communication Protocol	MODBUS
Communication address	1~247 (partial)
Baud rate (bit/s)	4.8k, 9.6k, 19.2k, 38.4k

Test function

Test release: It can carry out non-release test with simulated current, simulate long delay, short delay, instantaneous protection mode for testing; it can also carry out action test directly in order to detect the quadrature of the controller and the circuit breaker, and it can also carry out simulation test on the programmable output module.

Thermal memory protection
 Repeated overload may cause the conductor or equipment heating, the controller simulates the heating condition, in the overload long delay, short-circuit short delay and other fault delay action, with the thermal effect (simulation of bimetal characteristics). Overload long delay thermal effect energy in the fault removed after 30min release end, short circuit short delay thermal effect energy in the fault removed after 15min release end. During this period, such as closing the circuit breaker again overload long delay, short-circuit short delay and other faults, the delay action time becomes shorter, so that the line or equipment to get more appropriate protection. If the controller is powered off once and then powered on again, the accumulated thermal effects are all cleared.

Accessory Functions and Features



EHWSDC-2500/4000 Closed solenoid

□Closing solenoid

When the circuit breaker has completed the energy storage operation and is in the normal opening state, the closing solenoid can be used to control the circuit breaker from a distance to make the circuit breaker close quickly.

Operating voltage Us	AC230V	AC400V	DC220V	DC110V
Operating voltage range	(85~110)%Us			
Starting current	1.3A	0.7A	1.3A	2.5A
Suction time	≤60ms			



EHWSDC-2500/4000 shunt disconnect

□Shunt excitation disconnectors

When the circuit breaker is in the closing state, a shunt release can be used to control the circuit breaker from a distance to make the circuit breaker open quickly.

Operating voltage Us	AC230V	AC400V	DC220V	DC110V
Operating voltage range	(70~110)%Us			
Starting current	1.3A	0.7A	1.3A	2.5A
Suction time	≤30ms			



EHWSDC-2500/4000 Energy storage motor

□Energy storage motor

Realize the electric energy storage of circuit breaker and automatic energy storage operation again after the circuit breaker is closed, so that the circuit breaker can be closed again immediately after breaking.

Operating voltage Us	AC230V	AC400V	DC220V	DC110V
Operating voltage range	(85~110)%Us			
Energy storage time	5s			
NLDW5DC-2500	110VA		110W	
NLDW5DC-4000	150VA		150W	

Note: Manual energy storage operation is also possible during circuit breaker maintenance



EHWSDC-2500/4000 Auxiliary switch

□Auxiliary contacts

Default configuration: four sets of changeover contacts
Other types: four normally open and four normally closed, six sets of changeover contacts, six normally open and six normally closed

Operating voltage Us	AC230V	AC400V	DC220V	DC110V
Conventional heating current	6A			
Rated control capacity	300VA		60W	



partition between phases

□Interphase Spacer

Installed vertically between the terminal busbars of each phase of the circuit breaker, used to enhance the insulation capacity between the phases of the circuit breaker.



Interrupter locking device

Phase break lockout device

Locks the circuit breaker's break button in the down position, which prevents the circuit breaker from being closed.

Note 1: When the key is to be removed, the key must be removed by pressing and holding the break button and then turning it counterclockwise.
Note 2: The following list is for reference only. Interlocks can be installed according to the actual power supply system on site, or consult the manufacturer for negotiation.

Mode 1: One power supply, one load interlocking

Circuit diagram Possible Mode of Operation



A lock and a key: A circuit breaker is equipped with a lock and a key, which does not allow the circuit breaker to be closed in a locked state.

Mode 2: Two power supply and one load interlocking

Circuit diagram Possible Mode of Operation

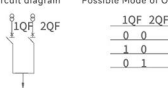

Two locks and one key: Two circuit breakers with two identical locks and one key, allowing only one circuit breaker to close.

Mode 3: Interlocking of two power supplies and two loads

Circuit diagram Possible Mode of Operation

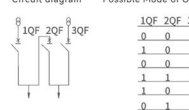

Three locks and two keys: three circuit breakers with three identical locks and two keys, allowing only a maximum of two circuit breakers to close.

Mode 4: Three-way power supply and one-way load interlocking

Circuit diagram Possible Mode of Operation

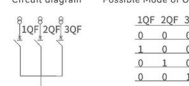

Three locks and one key: Three circuit breakers with three identical locks and one key, allowing only one circuit breaker to close.



Door frame

□Door frame

The door frame is mounted on the door where the circuit breaker is installed in the switchgear cabinet, which plays the role of sealing and aesthetics, and the protection level can reach IP40.



□Drawer operation padlock

When the body of a drawer-type circuit breaker is in the "detached" position, pull out the card plate and lock it with a padlock, which prevents the body from being swung to the "test" or "connected" position. Position: (For padlock, please provide your own).



Relay Modules

□ Relay Module
 Input Voltage: DC24V
 Contact capacity: AC250V10A; DC28V 10A
 When the load capacity carried by the control breaker's opening and closing is large, it needs to be converted by the relay module before control.
 The mounting method adopts 35mm standard guide rail or direct mounting in two ways.



Voltage Conversion Module

□ Voltage conversion module
 1. The voltage conversion module is designed to extend the voltage measurement range of the intelligent controller in case of high bus voltage. This module needs to be used together with the controller.

□ Mechanical interlocking
 Steel cable interlocking of two flat circuit breakers or linkage interlocking of two stacked circuit breakers.

Two power sources and one load can only be combined with one circuit breaker.

Circuit diagram Possible Mode of Operation

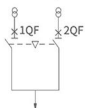

1QF	2QF
0	0
0	1
1	0

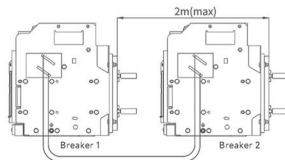

Cable interlocking or red interlocking of three circuit breakers
 Three-way power and one-way load can only be combined with one circuit breaker

Circuit diagram Possible Mode of Operation



1QF	2QF	3QF
0	0	0
1	0	0
0	1	0
0	0	1

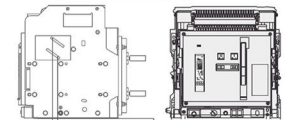

Maximum of two circuit breakers for two power sources and two loads

Circuit diagram Possible Mode of Operation

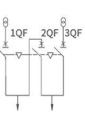

1QF	2QF	3QF
0	0	0
1	0	0
0	1	0
1	1	0
0	0	1
1	0	1

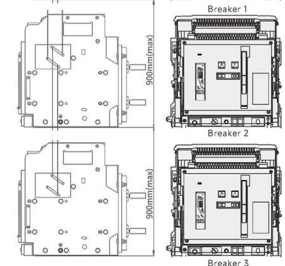

QF: Circuit breaker
 Note: The transition arc at the interlocking bend of the steel cable is not less than R120mm.



Remote Controller

□ Remote Controller
 Meet the user on the EHV5DC product wireless remote control or remote alarm to the user, remote control, remote alarm to SMS command execution, short: letter content can be customized by the user.
 Application areas: power industry, telecommunications industry and other unattended equipment room monitoring and remote maintenance. Alarm input signal: can be connected to smoke, infrared, switch detection and other sensors, to achieve the SMS alarm function, when there is an alarm signal, you can send a text message to multiple cell phones for reminding, and then the user to the remote controller to send SMS commands for control. Installation: 35mm standard rail mounted.

Remote Controller Wiring Diagram

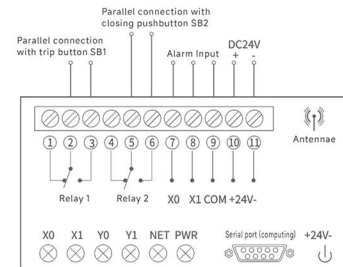

□ Remote Controller Terminal Interpretation
 ①, ② is the output terminal of relay 1, ③ is the input terminal of relay 1, AC230/400V load can be connected, the output current is 5A; X0 is the indicator light of relay 1, light ①, ② is disconnected, ③, ④ is closed.
 ⑤, ⑥ is the output terminal of relay 2, ⑦ is the input terminal of relay 2, which can be connected to AC230/400V load, and the output current is 5A; X1 is the indicator light of relay 2, light ⑤, ⑥ is disconnected, ⑦, ⑧ is closed.
 ⑨-⑩ for the two alarm signal inputs, ⑪ for the public terminal, connected to the smoke, infrared, detection and other sensors; 0 for the ⑫, ⑬ alarm signal lamp, Y1 for the ⑭, ⑮ alarm signal lamp, the light indicates that there is a signal input.
 ⑯, ⑰ for the remote controller input power, the lower end of the input power supply, only one way to input power can work properly, the voltage is DC24V; WET for the network indicator, when installed correctly, turn on the power supply, NET light will flash once a second, said to be looking for the network, when the NET light flashes from 1 second to 3 seconds blinking, the remote controller connected to the network is successful, you can carry out remote control.
 PWR is the power indicator light, when the light is always on, it means the power is connected normally and can work.
 Serial port is the data interface for the computer to connect the remote controller for various settings, need to install the driver and special configuration software.
 Antenna in order to remote controller has a better reception of network signals and configuration, even in the network signal is not good place can work normally, the length of the antenna for 2m.

> EHW5DC-2500HU Outline and Installation Dimension Drawing

EHW5DC-2500 Drawer type circuit breaker (3 poles)

EHW5DC-2500 Drawer type circuit breaker (4 poles)

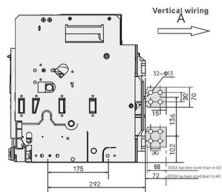
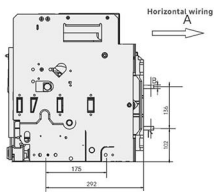
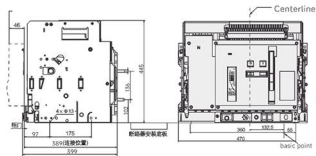
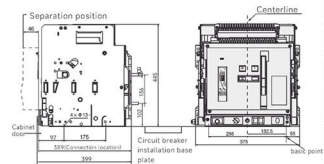

Standard horizontal wiring

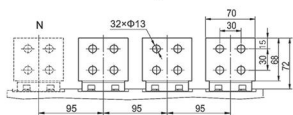

Note: (800A has been sized down to 63)

Vertical wiring



Rated current (A)	Dimension B (mm)
630-800	10
1000-1600	15
2000-2500	20

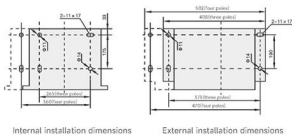

Internal installation dimensions

External installation dimensions

> EHW5DC-2500 Outline and Installation Dimension Drawing

EHW5DC-2500 fixed type circuit breaker (3 poles)

EHW5DC-2500 fixed type circuit breaker (4 poles)

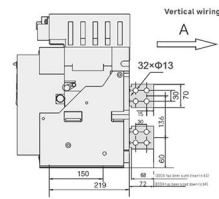
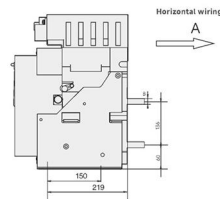
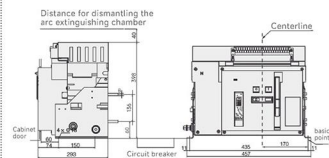
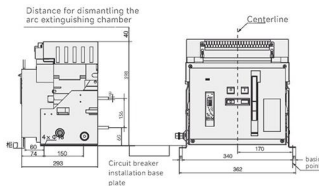

Standard horizontal wiring

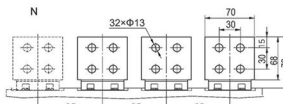

Note: (800A has been sized down to 63)

Vertical wiring

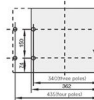
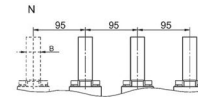

Installation dimensions

Rated current (A)	Dimension B (mm)
630-800	10
1000-1600	15
2000-2500	20

> EHW5DC-4000 Outline and Installation Dimension Drawing

EHW5DC-4000 Drawer circuit breaker (3 poles)

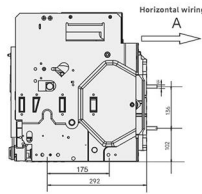
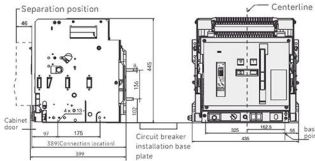

Standard horizontal wiring

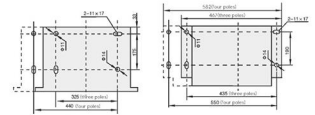
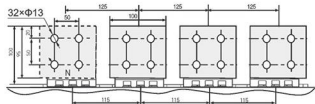

Internal installation dimensions

External installation dimensions

EHW5DC-4000 Drawer circuit breaker (4 poles)

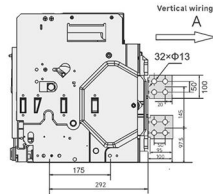
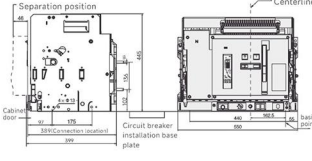

Vertical wiring

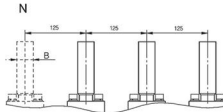

Rated current (A)	Dimension B (mm)
2000, 2500	20
2900, 3200	30
3600, 4000	30

> EHW5DC-4000 Outline and Installation Dimension Drawing

EHW5DC-4000 Fixed type circuit breaker (3 poles)

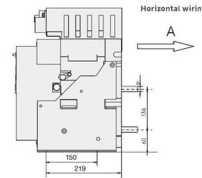
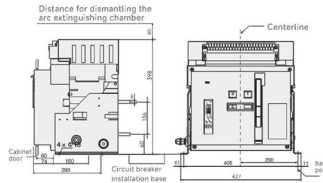

Standard horizontal wiring

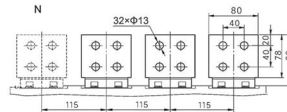

Installation dimensions

EHW5DC-4000 Fixed type circuit breaker (4 poles)

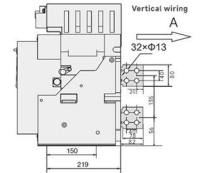
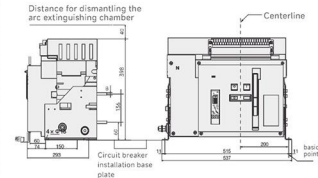

Vertical wiring

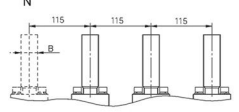

Rated current (A)	Dimension B (mm)
2000, 2500	20
2900, 3200	30
3600, 4000	30

H Secondary Wiring Diagram of Type I Controller

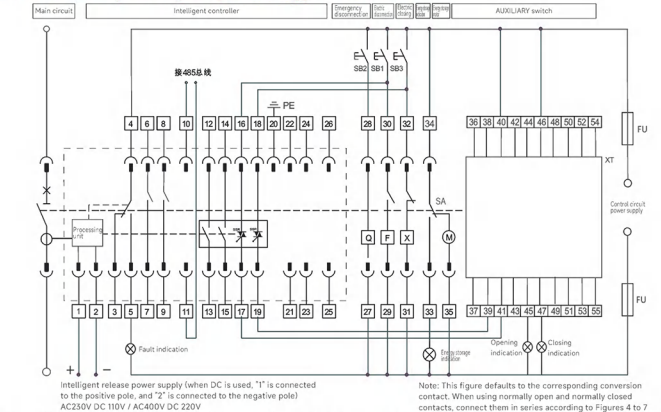

Intelligent release power supply (when DC is used, "1" is connected to the positive pole, and "2" is connected to the negative pole)
 AC230V DC 110V / AC400V DC 220V

Note: This figure defaults to the corresponding conversion contact. When using normally open and normally closed contacts, connect them in series according to Figures 4 to 7

- 1 # and 2 #: Controller auxiliary power supply, with 1 # as the positive pole when the power supply is DC
- 3 #, 4 #, 5 #: Fault tripping contact output, 4 # is a common point
- 6 #-9 #: Two sets of auxiliary contact opening points are commonly used (according to Figure 3 when customizing six sets of conversion contacts, and according to Figure 7)
- 10 # and 11 #: when customizing six normally open and six normally closed contacts: RS485 communication interface A and B ends
- 12, 13 #: Load 1 alarm signal output
- 14, 15 #: Load 2 alarm signal output
- 16, 17 #: Remote opening control output (DO3 bidirectional silicon controlled power electromagnetic coil)
- 18 #, 19 #: Remote closing control output (DO4 bidirectional silicon controlled power electromagnetic coil)
- 20 #: Protective ground wire
- 21 #: N-phase voltage signal input
- 22 #: A-phase voltage signal input
- 23 #: B-phase voltage signal input
- 24 #: C-phase voltage signal input
- 25 #, 26 #: External transformer signal input terminal (blank when not available)
- 27 #, 28 #: Under-voltage release power supply (G)
- 29 #: 30 #: Shunt release power supply (F)
- 31 #, 32 #: Close the electromagnetic power supply (X)
- 33 #: Energy storage indication
- 34 #, 35 #: Energy storage motor power supply

Figure 2 Five sets of conversion contact (customized as needed)

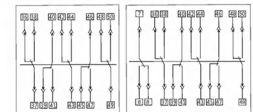

Figure 3 Six sets of conversion contacts (customized as needed)

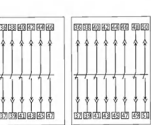

Figure 4 Four normally open and four normally closed contacts

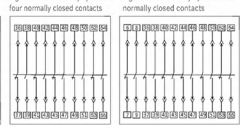

Figure 1: Four sets of conversion contacts (default configuration)

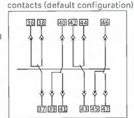

Figure 5 Four normally open and six normally closed contacts

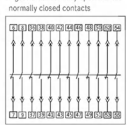
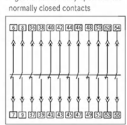
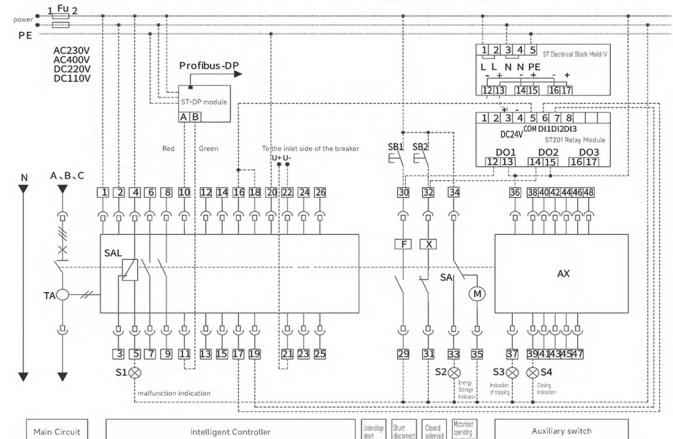

Figure 6 Six normally open and six normally closed contacts



H-type controller (with relay module) secondary wiring diagram



Note: The virtual line part is connected by the user, if the voltage of intelligent controller, shunt release, closing solenoid, electric operating mechanism, etc. are different, they should be connected to different power supply separately, when the rated working voltage of the main circuit is DC500V~DC1500V, the control and auxiliary circuits need to be isolated from the main circuit with a transformer and the maximum working voltage of the control and auxiliary circuits is AC400V.

H-type controller (with relay module) secondary wiring diagram function and symbol definition

Terminal number	Function Description	notation	interpretation	note
1, 2	Auxiliary power input: AC230V, AC400V, DC220V, DC110V			User Supplied
3, 4, 5	Fault trip auxiliary contact, contact capacity: AC250V, 3A	S1-S4	Signal lamps	
10, 11	Communication interface output, 10 for (A), 11 for (B), (Note: default Modbus-RTU communication mode)	TA	Current Transformer	
12-15	DO1, programmable signal output, contact capacity: AC250V, 3A	SAL	Microswitch	User Supplied
14, 15	DO2, programmable signal output, contact capacity: AC250V, 3A	SB1	Split Buttons	User Supplied
16, 17	DO3, breaking signal output, contact capacity: AC250V, 3A	SB2	Closing pushbutton	
18, 19	DO4, closing signal output, contact capacity: AC250V, 3A	X	Closing solenoid	
20	Grounding (PE)	F	Separate excitation disconnectors	
21, 22	Voltage signal measurement, power supply positive and negative	M	MotORIZED operating mechanism	
29, 30	Separate excitation detacher	SA	Electric operating mechanism travel switch	
31, 32	Closing solenoid	FU	Fuse	User Supplied
33, 34, 35	Electric operating mechanism: electric energy storage, 33 to the green line, 34 to the black line, 35 to the red line	PE	Ground wire	
36-48	Auxiliary contact terminal	AX	Auxiliary contacts	
		ST-DP Module	Required for Profibus-DP communication	Optional
		ST Power Module	Required for communication function	Optional
		ST201 Relay Module	Required for communication function	Optional

Busbar fixing

Correct fastening of the busbar depends on the proper torque of the bolts and nuts. If the torque is too large, it is easy to slip the wire, and if the torque is too small, it will not be able to play the role of fastening, and both of them will cause the temperature rise to be too high. For the connection of circuit breakers, the torque requirements of fasteners are shown in Table 10. Busbar should be taken up and down are installed, which is to increase the contact area, multi-piece installation, each piece of busbar separated by 10mm, to increase the heat dissipation between the busbar. See the figure below.



Table 10

Bolt Type	Applications	Torque size (N·m)
M3	Fastening of secondary terminals	0.4-0.5
M10	Fastening busbar	36-52
M12	Fastening busbar	61-94

Common Troubles and Troubleshooting Methods

Table 11

No.	fault phenomenon	Causes	Methods of elimination
1	Breaker will not close	<input type="checkbox"/> No supply voltage to undervoltage striker, not connected. <input type="checkbox"/> The red button on the upper part of the controller panel is not reset after the smart controller is actuated. <input type="checkbox"/> The operating mechanism does not store energy. <input type="checkbox"/> Drawer not in "connect" or "test" position <input type="checkbox"/> Disconnected position key lock" in locked position	<input type="checkbox"/> Check the wiring and turn on power to the undervoltage striker. <input type="checkbox"/> Press the reset button <input type="checkbox"/> Manually or electrically energize the mechanism <input type="checkbox"/> Swing the circuit breaker body to the "connect" or "test" position with the handle. <input type="checkbox"/> Unlock the key lock with the special key
2	Circuit breakers cannot store energy electrically	<input type="checkbox"/> Power supply to the electric operating mechanism is not switched on <input type="checkbox"/> Insufficient power supply capacity	<input type="checkbox"/> Check wiring, turn on power <input type="checkbox"/> Check operating voltage >85% Ue
3	Closing solenoid does not close circuit breaker	<input type="checkbox"/> No supply voltage <input type="checkbox"/> Insufficient power supply capacity.	<input type="checkbox"/> Check wiring, turn on power <input type="checkbox"/> Check operating voltage >85% Ue
4	Failure of the shunt disconnector to open the circuit breaker	<input type="checkbox"/> No supply voltage <input type="checkbox"/> Insufficient power supply capacity.	<input type="checkbox"/> Check wiring, turn on power <input type="checkbox"/> Check operating voltage greater than 70% Ue
5	Fault current are more than the long delay, short delay, instantaneous set value, only instantaneous action, no short delay, long delay action	Long delay, short delay, instantaneous set value setting value set unreasonable, set in the same current value range	Reset according to the principle of $I_r < I_{r2} < I_{r3}$ and considering its operation range
6	Frequent tripping of circuit breakers	Site overload operation caused the overload protection to trip, and then reclosed due to the overload thermal memory function failing to clear the power failure in time.	The controller is disconnected once, or the circuit breaker is reclosed after 30min
7	Drawer type circuit breaker rocker handle cannot be inserted into the circuit breaker	Drawer rail or breaker body not fully pushed in	Push the rail or breaker body to the bottom
8	The body of the drawer type circuit breaker cannot be withdrawn from the circuit breaker when it is in the disconnected position	Crank handle not pulled out Circuit breaker not fully in "breakaway" position	Pull out the rocker handle and swing the circuit breaker all the way to the "breakaway" position.

Ordering Information

(Please put a $\sqrt{}$ in or fill in the numbers)

User unit	Order Quantity	order date	
Model	<input type="checkbox"/> EHW5DC-2500 <input type="checkbox"/> EHW5DC-4000	rated voltage <input type="checkbox"/> DC500V <input type="checkbox"/> DC750V <input type="checkbox"/> DC1000V <input type="checkbox"/> DC1500V	
	<input type="checkbox"/> Fixed <input type="checkbox"/> Drawer-type	Rated current In A Busbar connection method <input type="checkbox"/> level <input type="checkbox"/> vertical (Note: Fixed type has only horizontal connection)	
Number of poles, power supply/load wiring method	<input type="checkbox"/> 2P string wiring; <input type="checkbox"/> 3P string A-type wiring (<input type="checkbox"/> A1, <input type="checkbox"/> A2, <input type="checkbox"/> A3, <input type="checkbox"/> A4, <input type="checkbox"/> A5); <input type="checkbox"/> 3P string B-type wiring (<input type="checkbox"/> B1, <input type="checkbox"/> B2); Note: 2P string is a wiring method 4P string C-type wiring (<input type="checkbox"/> C1, <input type="checkbox"/> C2, <input type="checkbox"/> C3, <input type="checkbox"/> C4, <input type="checkbox"/> C5, <input type="checkbox"/> C6, <input type="checkbox"/> C7, <input type="checkbox"/> C8); 4P string D-type wiring (<input type="checkbox"/> D1, <input type="checkbox"/> D2).		
protective function	Selection of protection functions	Default factory settings $I_r=1In, T_r=15s$ Definite time-limit $I_{sd}=5Ir, T_{sd}=0.4s$ Anti time-limit $I_{sd}=OFF, I_i=10In$ Long time-delay setting current (I _r) $I_r=$ _____ In (OFF (0.4-1.0) or OFF) $T_r(1.5Ir)=$ _____ s(select within 15, 30, 60, 480) Short time-delay setting current (I _{sd}) $I_{sd}=$ _____ Ir (OFF (1.5-15) or OFF) <input type="checkbox"/> Definite T _{sd} = _____ s (LCD type select within 0.1-0.4); <input type="checkbox"/> Anti time-limit TSD=0.1Tr time-limit Instantaneous setting current (I _i) $I_i=$ _____ In (LCD type select within 0.1-0.4)	
	Other Functions	<input checked="" type="checkbox"/> Communications function <input type="checkbox"/> Function test, fault memory, thermal memory, self-diagnostics, current measurement, fault alarm, ground fault protection, load monitoring <input type="checkbox"/> Signal contact output <input type="checkbox"/> Voltage measurement <input type="checkbox"/> voltage protection <input type="checkbox"/> Electrical Energy Measurement <input type="checkbox"/> Record of number of operations	
	Accessory Configuration	Separate excitation disconnectors	<input type="checkbox"/> AC230V <input type="checkbox"/> AC400V <input type="checkbox"/> DC220V <input type="checkbox"/> DC110V
		Closing solenoid	<input type="checkbox"/> AC230V <input type="checkbox"/> AC400V <input type="checkbox"/> DC220V <input type="checkbox"/> DC110V
MotORIZED operating mechanism		<input type="checkbox"/> AC230V <input type="checkbox"/> AC400V <input type="checkbox"/> DC220V <input type="checkbox"/> DC110V	
Optional accessories	Auxiliary switch	<input type="checkbox"/> 4 sets of changeover contacts <input type="checkbox"/> 4 Normally Open <input type="checkbox"/> 4 Normally Closed <input type="checkbox"/> 6 sets of changeover contacts <input type="checkbox"/> 6 Normally Open <input type="checkbox"/> 6 Normally Closed	
	<input type="checkbox"/> One lock and one key	<input type="checkbox"/> Two locks and a key <input type="checkbox"/> triple lock and two keys	
	<input type="checkbox"/> Mechanical interlock	Two circuit breakers <input type="checkbox"/> Interleaver interlocking (upper and lower interlocking) <input type="checkbox"/> Steel cable interlock Three circuit breakers <input type="checkbox"/> Interleaver interlocking (upper and lower interlocking) <input type="checkbox"/> Steel cable interlock	
	<input type="checkbox"/> Dedicated Power Module	<input type="checkbox"/> AC230V <input type="checkbox"/> AC400V	
	<input type="checkbox"/> DC Power Module	<input type="checkbox"/> DC220V <input type="checkbox"/> DC110V	
Other Special Requirements	<input type="checkbox"/> Drawer Block Communication Module Assembly (optional when three-position status signaling is required) <input checked="" type="checkbox"/> Standard: Door frame and its mounting screws, interphase spacer, wiring bolts		

Remarks: If there are other special requirements, please consult with us and specify in the order.