

EHS7 Series DC Isolator

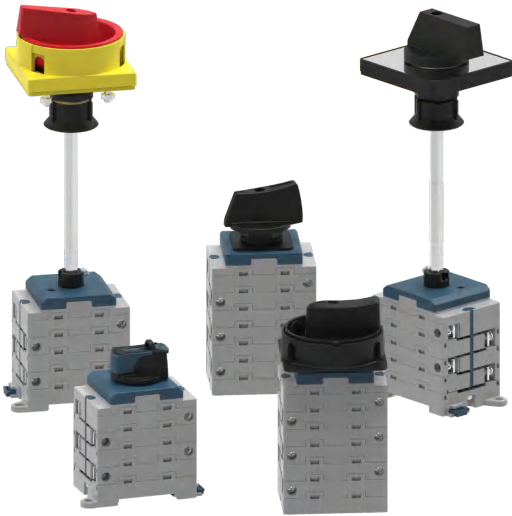

Product Benefits

- Non-polarity DC Isolator Switch
- Modular design, available 2-10 levels.
- Single Hole Mounting, Panel Mounting, Distribution Board, Door Clutch or Enclosure available.
- Dynamic sealing design and world class sealing materials guarantee an IP66 protection rate.
- DC 1500V insulation voltage design, passed IEC/EN60947-3, AS60947.3, UL508i,GB/T14048.3 test, TUV, CE, CB, SAA, UL, CCC available.
- Impact resistance: IK08
- Rated current: 13A, 20A, 25A, 40A, 50A,

Select Code

EH S □ □ / □ / □ □
 1 2 3 4 5 6 7

Code	Name	Description
1	elehub brand	EH
2	Isolation Switch	S
3	Series	7: Series 7
4	Mounting Type	DB: Distribution Board PM: Panel Mounting DC: Door Clutch HM: Hole Mounting EL: Enclosed
5	1000V Rated Current	13: 13A 20: 20A 25: 25A 40: 40A 50: 50A UL 13: 13A 20: 20A 25: 25A 30: 30A 40: 40A
6	Pole	2:2P 3:3P 4:4P 6:6P 8:8P 10:10P 2H/3H/4H 4T/4B/4S UL 2:2P 3:3P 4:4P 6:6P 8:8P 10:10P
7	Konb look	R:lockable Nil:With out lock

Note* The direction of PM rotary buttons is 9 o'clock to close and 12 o'clock to open, and the rest of the rotary buttons are 12 o'clock to close and 3 o'clock to open. HM series rotary buttons have both the directions. If you have special needs, please kindly check with us.

EHS7 Series DC Isolator

Technical data

According to IEC/EN60947-3, AS60947.3:2018, UL508i, GB/T14048.3, Utilization category DC-PV1/DC-PV2.

Model	A	13	20	25	40	50	
Rated insulation voltage	U _i	V	1600	1600	1600	1600	1600
Rated thermal current	I _{th}	A	32	40	55	55	63
Rated impulse withstand voltage	U _{imp}	V	8000				
Rated short-time withstand current (1s)	I _{cw}	A	780				
Rated short-time making capacity	I _{cm}	A	1200				
Maximum cable cross sections (incl. jumper)							
Solid or standard		mm ²	4-16				
Flexible		mm ²	4-16				
Flexible (+ multicore cable end)		mm ²	4-16				
Torque							
Tightening torque terminal screws M4.		N·m	1.2-1.8				
Tightening torque single hole mounting nut M16		N·m	2.0-2.3				
Tightening torque knob screws M3		N·m	0.5-0.7				
Switching on or off torque		N·m	0.9-1.3				
General parameters							
Knob positions			9 o'clock, OFF 12 o'clock, ON / 12 o'clock, OFF 3 o'clock, ON				
Electrical Life	Actual		3000 Cycles				
	Standard		300 Cycles				
Mechanical Life	Actual		10000 Cycles				
	Standard		1000 Cycles				
Distance of contacts (per pole)			8mm				
Operation temperature			-40°C to +85°C				
Store temperature			-40°C to +85°C				
Pollution degree			3				
Overvoltage category			II				
IP rating of shafte and mounting nut			IP66				

Data according to IEC/EN60947-3, AS60947.3, UL508i, GB/T14048.3. Utilization category DC-PV1/DC-PV2.

EHS7 Series DC Isolator

Layers	EHS7 Voltage / current (DC-PV1)								Model
	600Vdc	800Vdc	1000Vdc	1100Vdc	1200Vdc	1300Vdc	1500Vdc	1600Vdc	
2/3/4/6/8/10	32	26	13	13	10	10	5	5	EHS7XX/13/YZ
	40	30	20	20	12	12	6	6	EHS7XX/20/YZ
	55	45	25	25	15	15	8	6	EHS7XX/25/YZ
	/	50	40	40	30	30	20	12	EHS7XX/40/YZ
	/	63	50	50	40	35	32	16	EHS7XX/50/YZ
4T/B/S	/	/	32	/	26	/	13	/	EHS7XX/13/YZ
	/	/	40	/	30	/	20	/	EHS7XX/20/YZ
	/	/	55	/	40	/	30	/	EHS7XX/25/YZ
	/	/	/	/	/	/	45	/	EHS7XX/40/YZ
	/	/	/	/	/	/	50	/	EHS7XX/50/YZ
3T/6T/9T	/	/	32	/	23	/	10	/	EHS7XX/13/YZ
	/	/	40	/	30	/	13	/	EHS7XX/20/YZ
	/	/	55	/	40	/	20	/	EHS7XX/25/YZ
	/	/	/	/	45	/	30	/	EHS7XX/40/YZ
	/	/	/	/	50	/	40	/	EHS7XX/50/YZ
2H	50	26	13	/	10	/	5	/	EHS7XX/13/YZ
	64	30	20	/	12	/	6	/	EHS7XX/20/YZ
	80	45	25	/	15	/	8	/	EHS7XX/25/YZ
	90	50	40	/	30	/	20	/	EHS7XX/40/YZ
	100	55	50	/	40	/	30	/	EHS7XX/50/YZ
3H	/	50	13	/	10	/	5	/	EHS7XX/13/YZ
	/	64	20	/	12	/	6	/	EHS7XX/20/YZ
	/	80	25	/	15	/	8	/	EHS7XX/25/YZ
	/	90	40	/	30	/	20	/	EHS7XX/40/YZ
	/	100	50	/	40	/	30	/	EHS7XX/50/YZ
4H	/	/	50	/	10	/	5	/	EHS7XX/13/YZ
	/	/	64	/	12	/	6	/	EHS7XX/20/YZ
	/	/	80	/	15	/	8	/	EHS7XX/25/YZ
	/	/	90	/	30	/	20	/	EHS7XX/40/YZ
	/	/	100	/	40	/	30	/	EHS7XX/50/YZ

Layers	EHS7 Voltage / current (DC-PV2)					Model
	600Vdc	800Vdc	1000Vdc	1200Vdc	1500Vdc	
2/3/4/6/8/10	13	13	6	4	3	EHS7XX/13/YZ
	20	15	8	6	4	EHS7XX/20/YZ
	25	23	10	8	5	EHS7XX/25/YZ
	40	30	20	15	8	EHS7XX/40/YZ
	50	40	25	18	10	EHS7XX/50/YZ
4T/B/S/3T/6T/9T	/	/	12	/	/	EHS7XX/13/YZ
	/	/	18	/	/	EHS7XX/20/YZ
	/	/	20	/	/	EHS7XX/25/YZ
	/	/	40	/	/	EHS7XX/40/YZ
	/	/	50	/	/	EHS7XX/50/YZ

EHS7 Series DC Isolator

According to UL 508i

Layers	EHS7 Voltage / current (UL 508i)					Model
	600VDC	800VDC	1000VDC	1200VDC	1500VDC	
2/3/4/6/8/10	30	25	13	10	5	EHS7XX/13/YZ
	40	30	20	13	5	EHS7XX/20/YZ
	40	40	25	16	10	EHS7XX/25/YZ
	40	40	30	16	16	EHS7XX/30/YZ
	40	40	30	16	16	EHS7XX/40/YZ

Note* 10P products needs to be customized, please kindly contact us if need them

Drawing Size

EHS7DC/...R

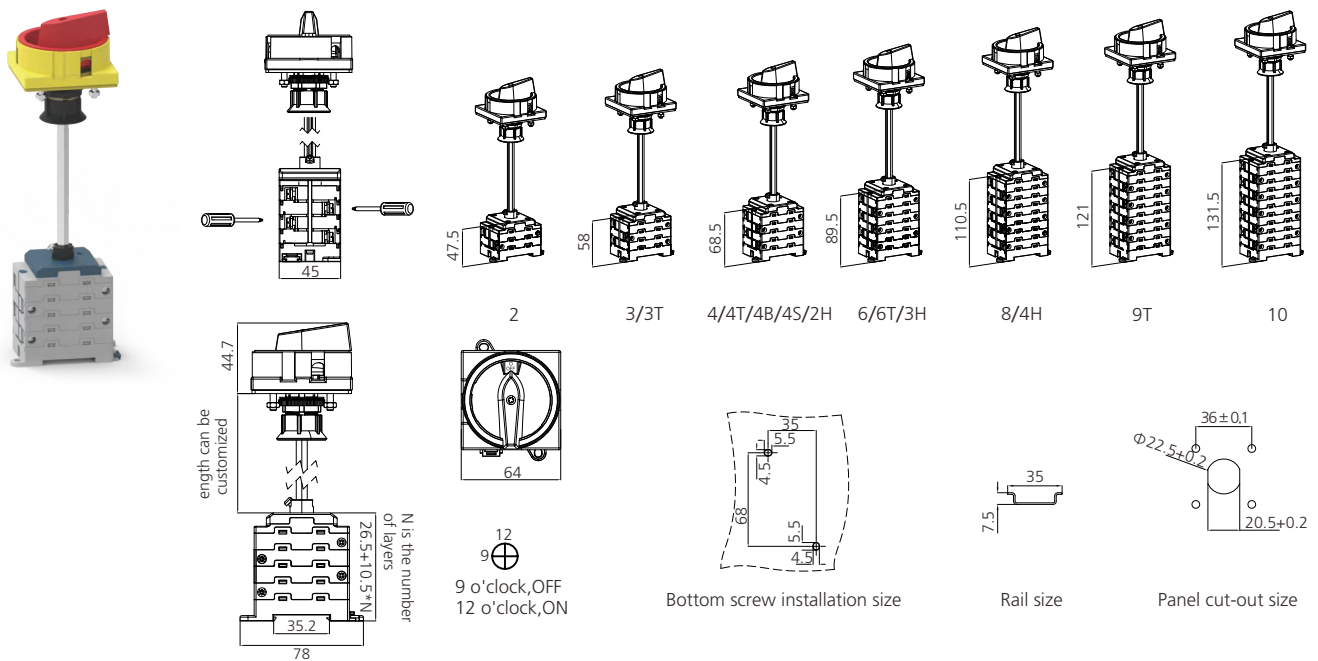

EHS7DC/...

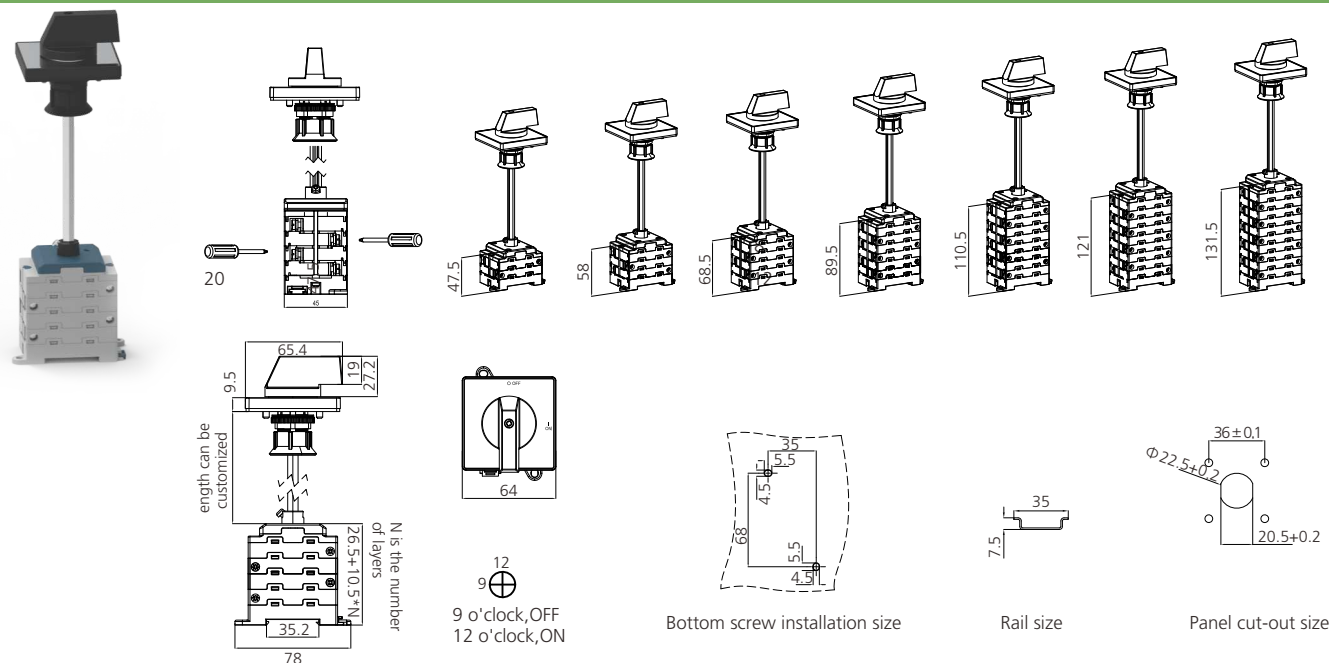

DC ISOLATION SWITCH



EHS7 Series DC Isolator

Drawing Size

EHS7DBR

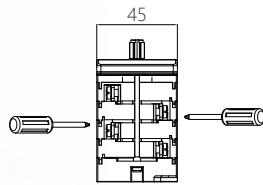

Wiring diagram

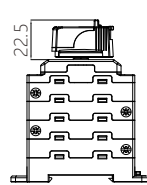

Head height

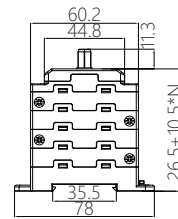

N is the number of layers

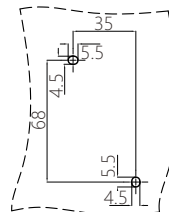
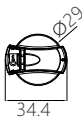
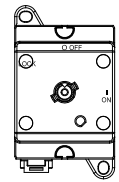

Bottom screw installation size

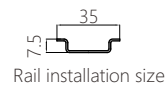

Rail installation size



12 o'clock, OFF
3 o'clock, ON

EHS7HM

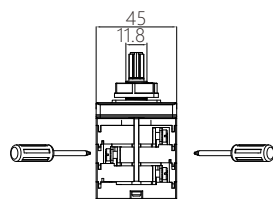

Wiring diagram

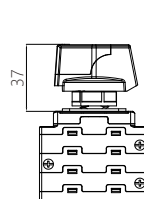

Head height

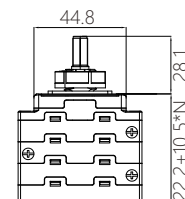

N is the number of layers

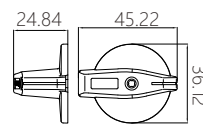
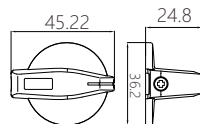
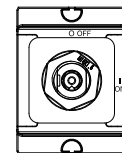

12 o'clock, OFF
3 o'clock, ON



9 o'clock, OFF
12 o'clock, ON

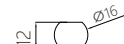

Hole Size

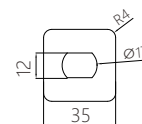

M16X1.5

EHS7 Series DC Isolator

Drawing Size

EHS7PMR

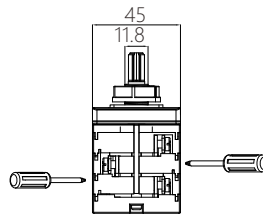

Wiring diagram

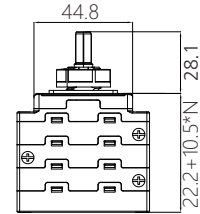

N is the number of layers

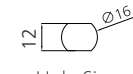
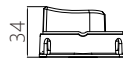
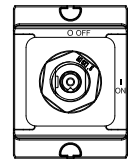

Hole Size

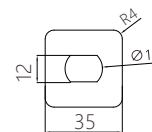
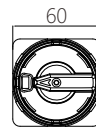

M16X1.5

EHS7HMR

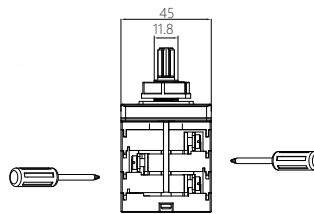

Wiring diagram

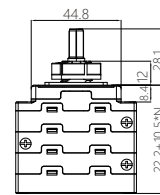

N is the number of layers

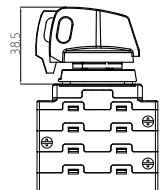
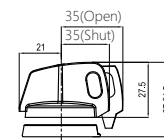

Head height

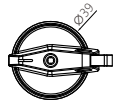
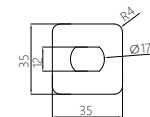
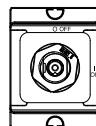

12 o'clock, OFF
3 o'clock, ON

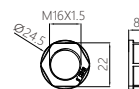

Hole Size

EHS7 Series DC Isolator

Wiring Diagram

