

CHR-80



Application

CHR Series quick disconnect battery connectors are used in a variety of applications, including: Materials Handling ,Aerial Platforms ,Sweeper /Scrubber ,Utility Vehicles(UTV), Motive Power, Battery Chargers.

CHR-80 MALE

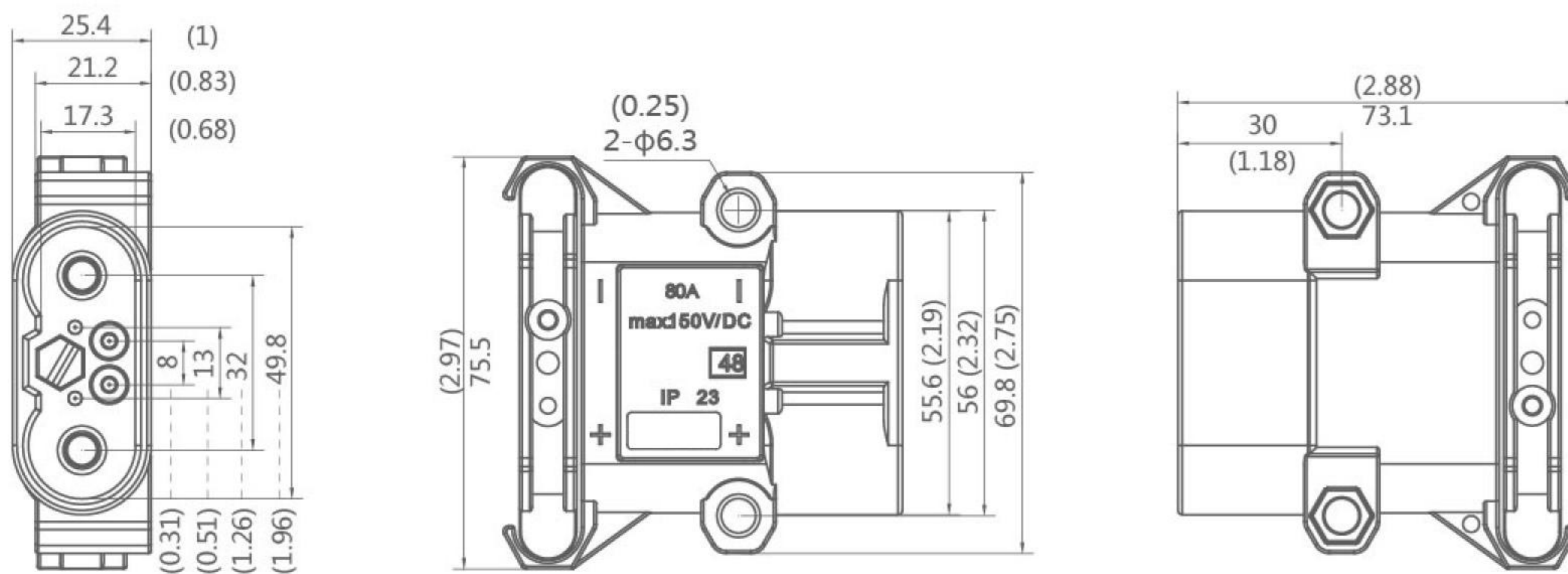

CHR-80 FEMALE

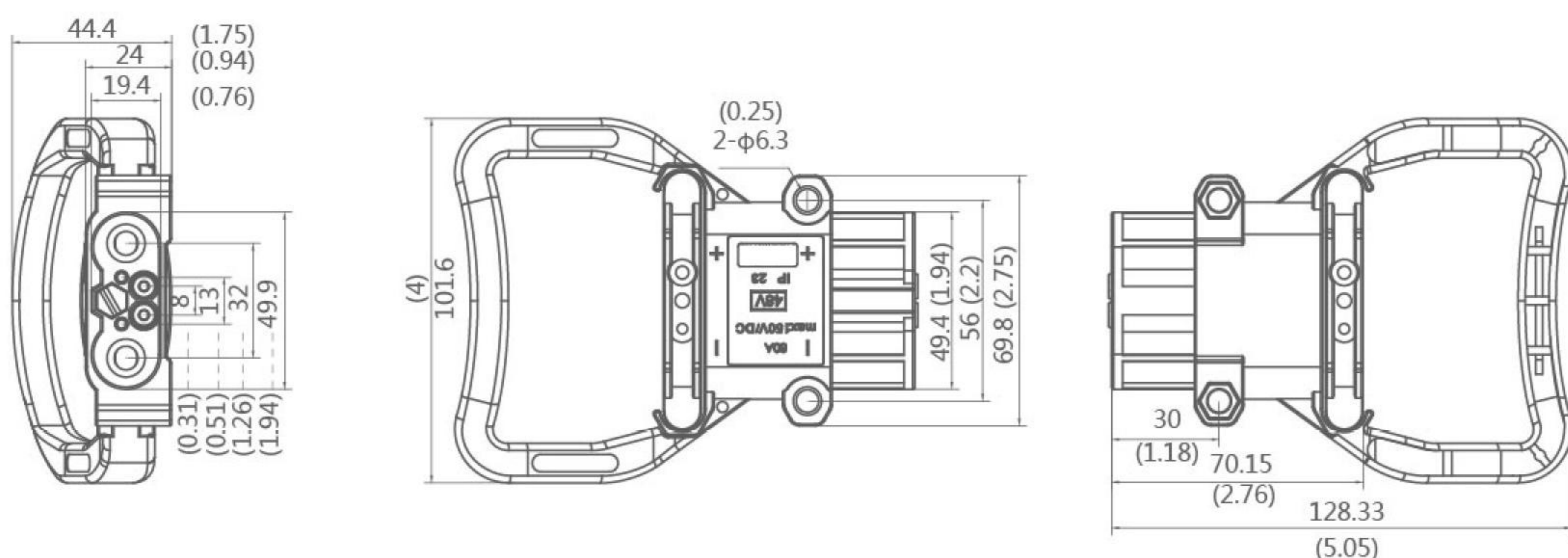

Part Number	Rated current	Rated voltage	Material of terminal	Color	Flammability	Wire
Housing	80A	150V	PA66	Grey/Black	UL94V-0	N/A
Chief Terminal	80A	150V	Copper with silver	Silvery	N/A	6AWG-4AWG
Upper Assist Terminal	15A	150V	Copper with silver	Silvery	N/A	18AWG-14AWG
Below Assist Terminal	15A	150V	Copper with silver	Silvery	N/A	18AWG-14AWG