



EFBS-H3 250-700A 1000V DC

Energy Storage Systems Fuse

- ♻️ Class of Operation: aR
- ♻️ Standard: GB/T 13539.4 IEC 60269-4
- ♻️ Breaking Capacity: 100kA
- ♻️ Time Constant: ≤15ms

Dimensions-mm

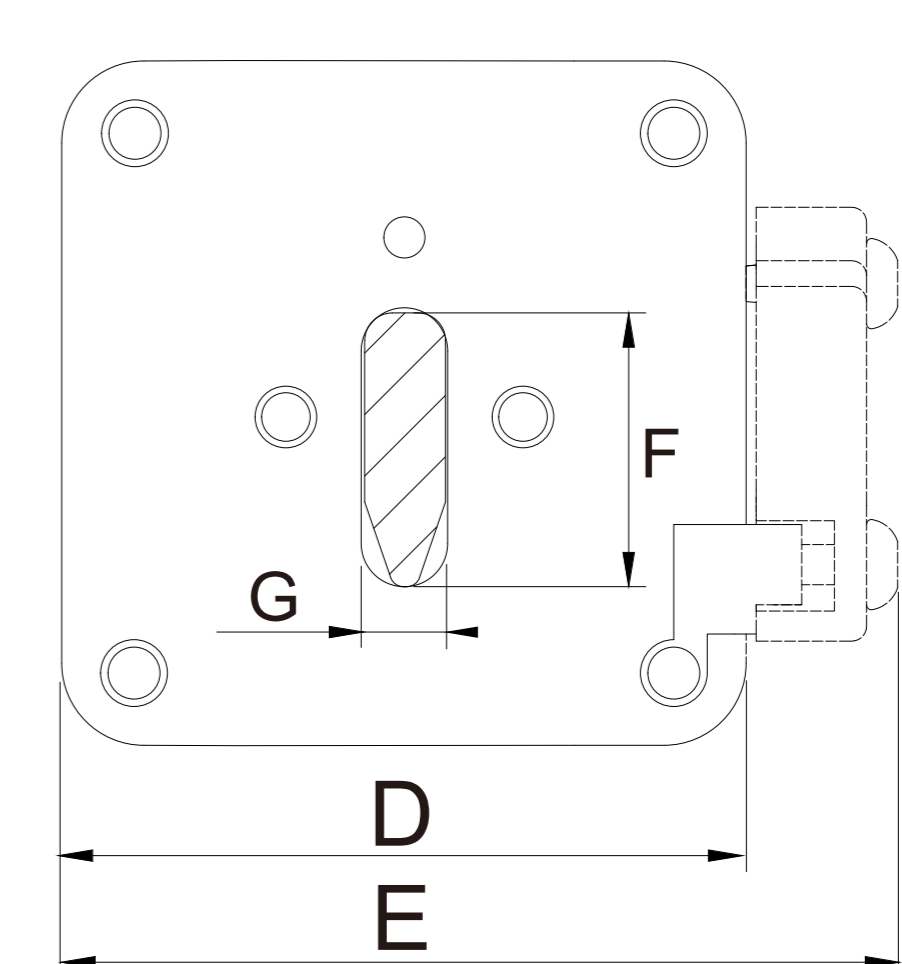
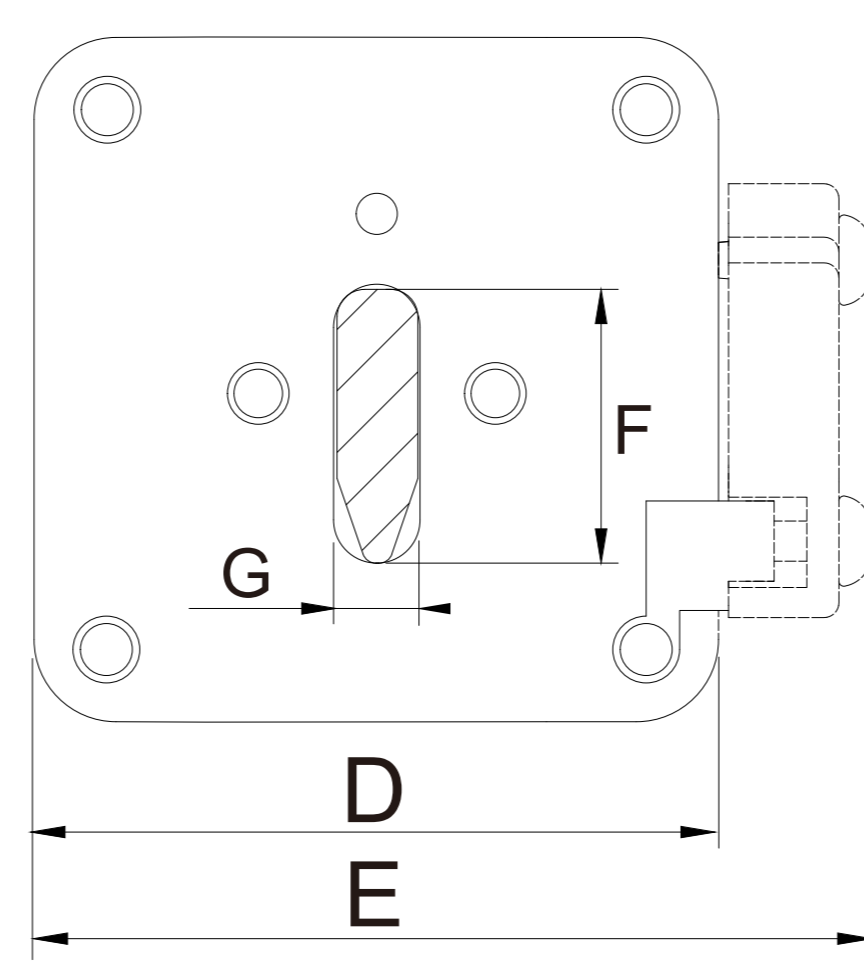
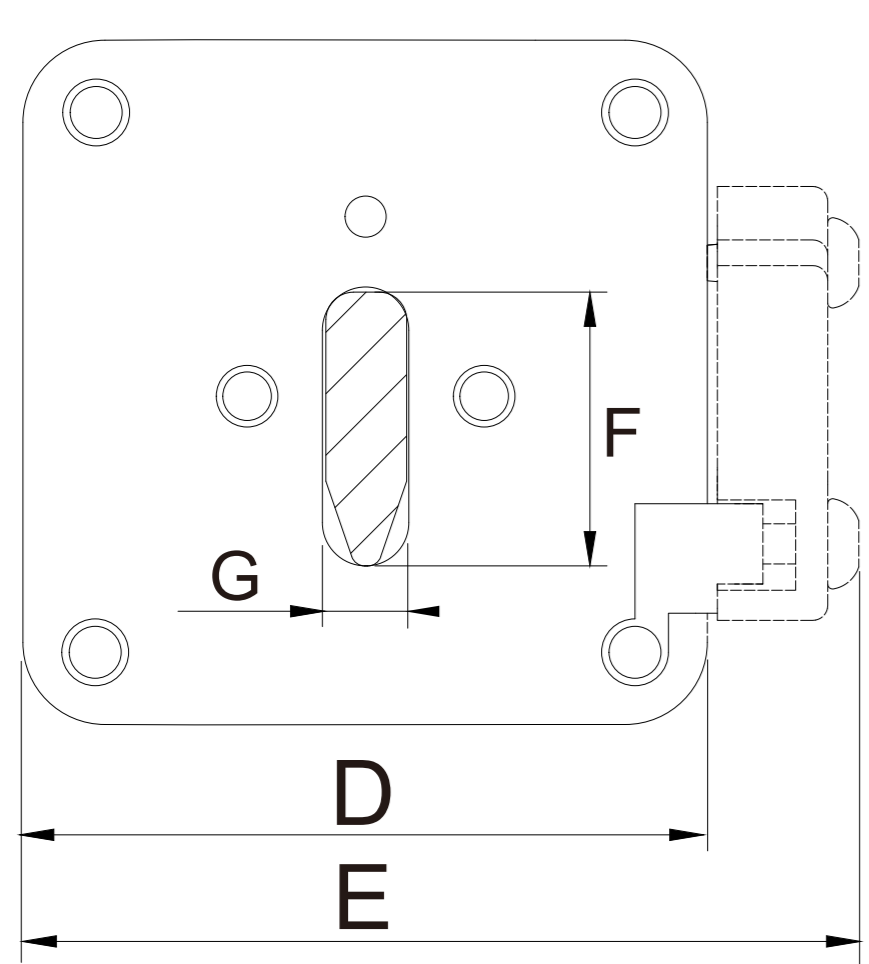
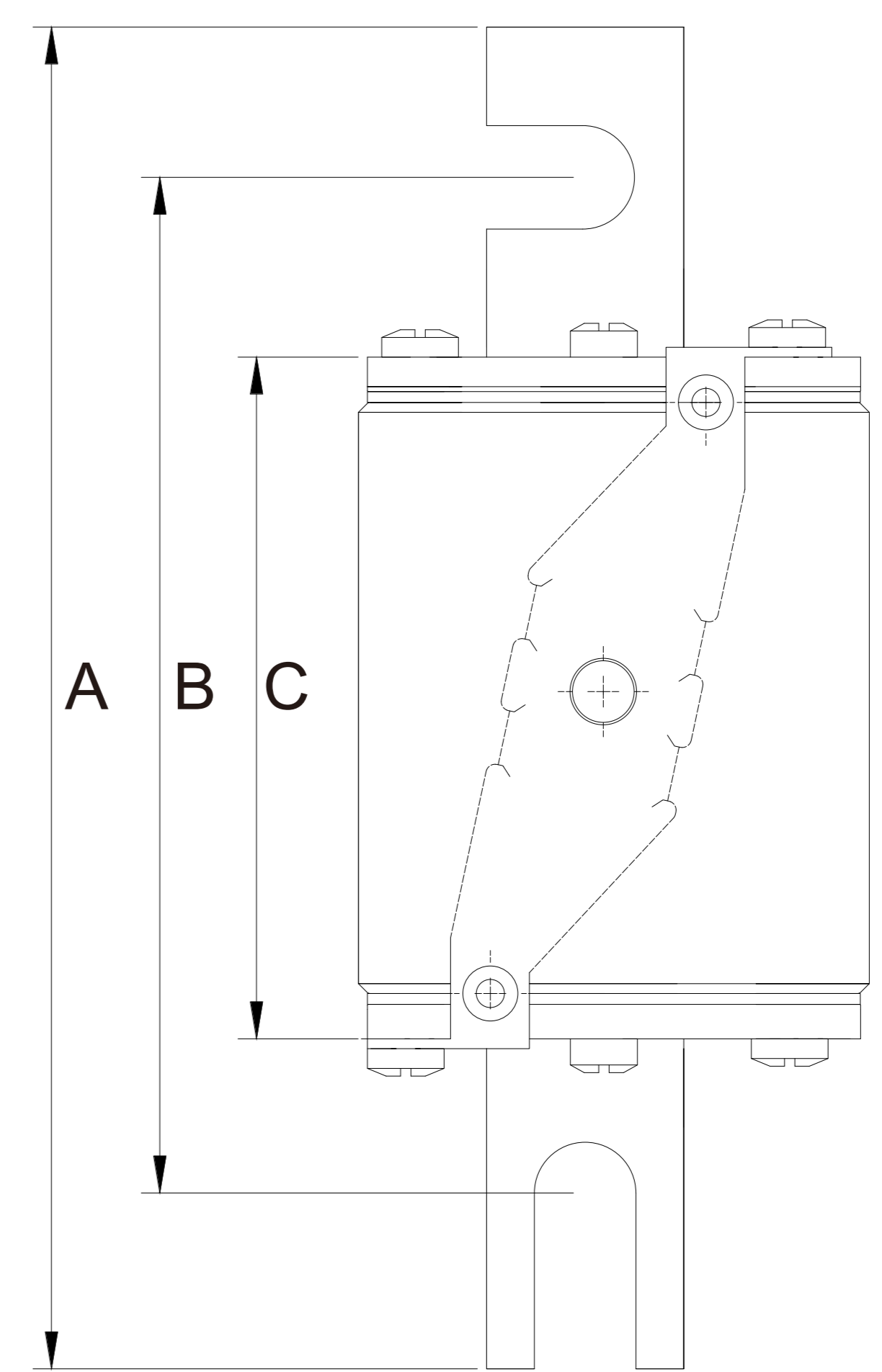
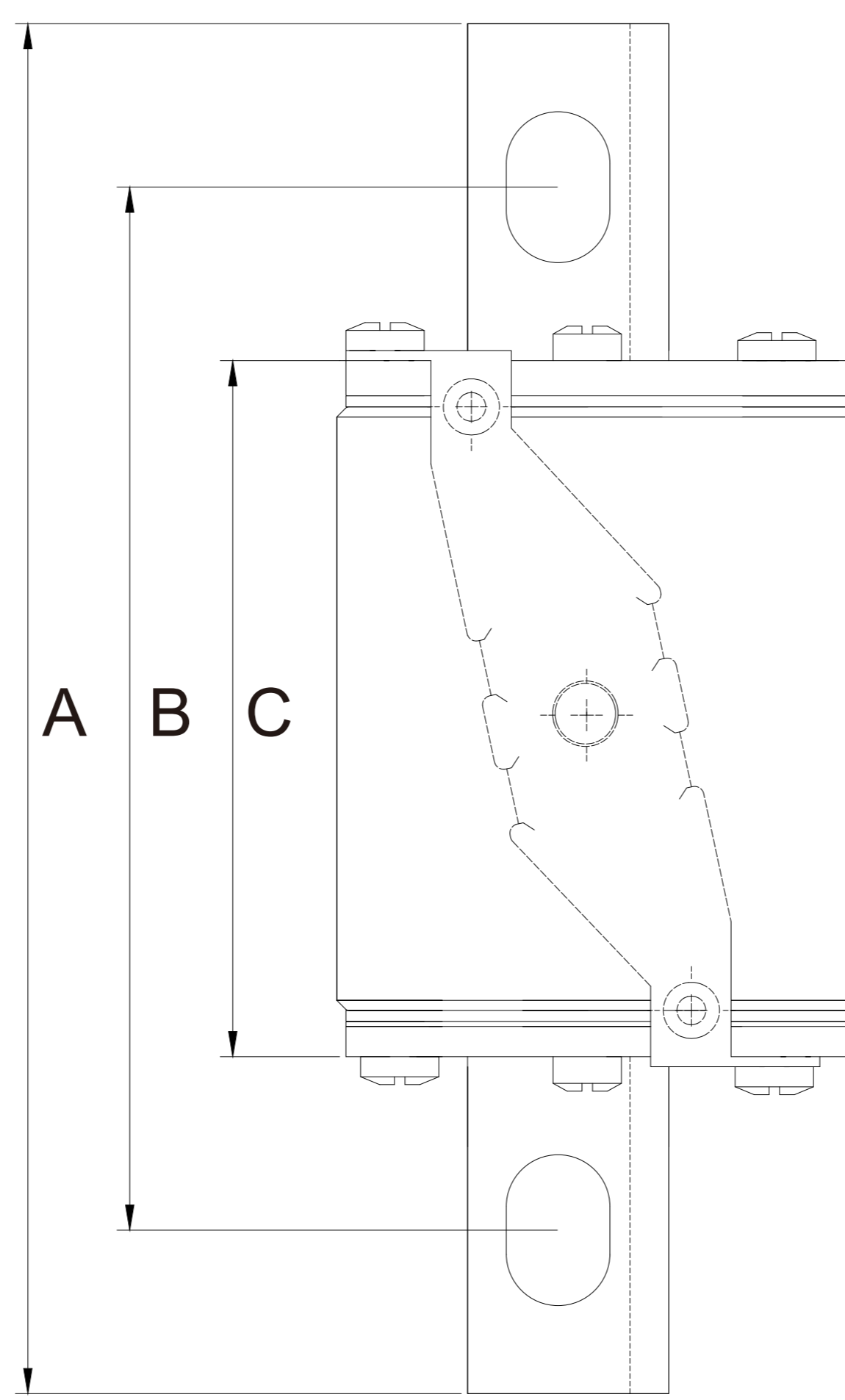
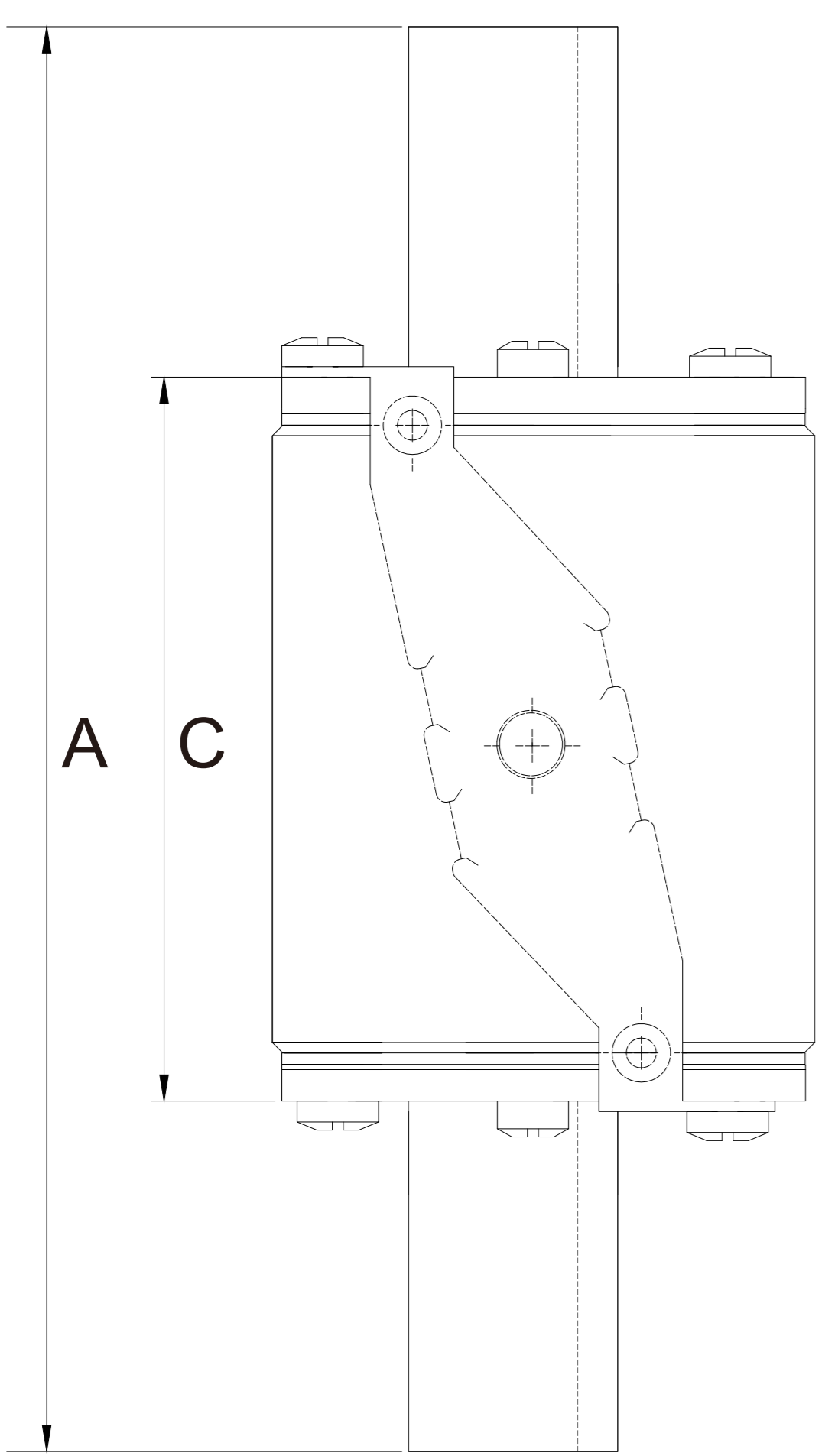

FIG. 1

FIG. 2

FIG. 3

Product No.	Dimension							FIG
	A	B	C	D	E	F	G	
EFBS-H01	138		72	43	58	20	6	1
EFBS-H1	133.5		68	48	63	20	6	
EFBS-H2	150		68.5	60	75	25	6	
EFBS-H3	150		68.4	74	90.5	32	6	
EFBS-H01-UB	138	103.5	72	43	58	20	6	2
EFBS-H1-UB	133.5	100.5	68	48	63	20	6	
EFBS-H2-UB	150	111.5	68.5	60	75	25	6	
EFBS-H3-UB	150	111.5	68.5	74	90.5	32	6	
EFBS-H01-DB	138	100.5	70	43	58	20	6	3
EFBS-H1-DB	138	100.5	68	48	63	20	6	
EFBS-H2-DB	160	129	68	60	75	25	6	
EFBS-H3-DB	160	129	68	74	90.5	36	6	